

ECS25,45 & 60 Series

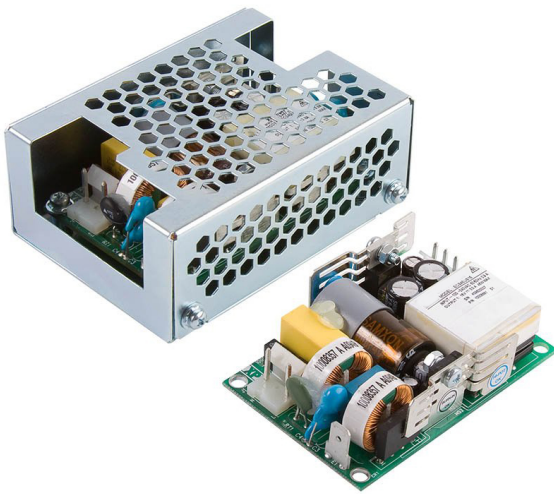

- IT & Medical Safety Approvals
- Very Small 2.0" x 3.0" Format
- Low Standby Power
- 25, 45 & 60 W – Convection Cooled Ratings
- High Convection Cooled Power Density up to 9.5 W/in³
- Class I & Class II Installations
- -20 °C to +70 °C Operation
- Low Earth Leakage Current
- 3 Year Warranty

The ECS25, 45 & 60 Series has been designed to minimise the no load power consumption and maximise efficiency in order to facilitate equipment design to the latest environmental legislation.

Approved for Class I and Class II applications, this range of single output AC-DC power supplies feature very high convection cooled power density in an industry leading 2" x 3" (51.0 mm x 76.2 mm) footprint. The very low profile, 1U compatible supplies meet EN55011/32 Level B conducted emissions with low earth leakage currents of 80 μ A at 115 VAC or 160 μ A at 230 VAC. Making these switchers ideal for industrial, IT and medical applications.

The series has single output versions from 5 V to 48 VDC, adjustable by $\pm 10\%$. They are dual-fused for compliance with IEC60601-1 and efficiency up to 89%, so minimal excess heat is generated. They will deliver up to 60 W of power at +50 °C and up to +70 °C with derating.

Models and Ratings

Output Power - Convection Cooled	Output Voltage V1	Max Output Current	Model Number ¹⁾
25 W	12.0VDC	2.08 A	ECS25US12
25 W	15.0VDC	1.67 A	ECS25US15
25 W	24.0VDC	1.04 A	ECS25US24
25 W	48.0VDC	0.52 A	ECS25US48
30 W	5.0VDC	6.00 A	ECS45US05
45 W	12.0VDC	3.75 A	ECS45US12
45 W	15.0VDC	3.00 A	ECS45US15
45 W	24.0VDC	1.90 A	ECS45US24
45 W	48.0VDC	0.95 A	ECS45US48
40 W	5.0VDC	8.00 A	ECS60US05 ¹
60 W	12.0VDC	5.00 A	ECS60US12
60 W	15.0VDC	4.00 A	ECS60US15
60 W	24.0VDC	2.50 A	ECS60US24
60 W	48.0VDC	1.25 A	ECS60US48

Notes

1. For covered versions, add suffix '-C' to model number or order part number ECS25-60 COVER KIT for standalone cover. Not suitable for use in class II installations, derate output power by 20% with cover.

Input Characteristics

Characteristic	Minimum	Typical	Maximum	Units	Notes & Conditions
Input Voltage - Operating	80	115/230	264	VAC	Derate output power < 90 VAC. See fig. 1
Input Frequency	47	50/60	400	Hz	Agency approval 47-63 Hz
Power Factor		>0.5			230 VAC, 100% load EN61000-3-2 class A compliant
Input Current - No Load		0.01/0.02		A	115/230 VAC
Input Current - Full Load		0.45/0.25 0.75/0.45 0.95/0.60		A	115/230 VAC - ECS25 115/230 VAC - ECS45 115/230 VAC - ECS60
Inrush Current			40	A	230 VAC cold start, 25 °C
No Load Input Power		0.3	0.5	W	115/230 VAC
Earth Leakage Current		80/160	260	µA	115/230 VAC/50 Hz (Typ.), 264 VAC/60 Hz (Max.)
		0.6/1.2		mA	115/230 VAC/400 Hz
Input Protection	T3.15A/250 V internal fuse in both line and neutral				

Output Characteristics

Characteristic	Minimum	Typical	Maximum	Units	Notes & Conditions
Output Voltage - V1	5.0		48	VDC	See Models and Ratings table
Initial Set Accuracy			±1	%	50% load, 115/230 VAC
Output Voltage Adjustment	±10			%	Via potentiometer. See mech. details (page 9)
Minimum Load	0			A	
Start Up Delay		1		s	230 VAC full load (see fig.2)
Hold Up Time	16			ms	115 VAC full load (see fig.3)
Drift			±0.2	%	After 20 min warm up
Line Regulation			±0.5	%	90-264 VAC
Load Regulation			±1	%	0-100% load.
Transient Response - V1			4	%	Recovery within 1% in less than 500 µs for a 50-75% and 75-50% load step
Over/Undershoot - V1		3		%	See fig.4
Ripple & Noise			1	% pk-pk	20 MHz bandwidth (see fig.5 & 6)
Overvoltage Protection	115		140	%	Vnom DC.
Overload Protection	110		200	% I nom	Auto reset (see fig.7)
Short Circuit Protection					Continuous, trip & restart (hiccup mode)
Temperature Coefficient			0.05	%/°C	
Overtemperature Protection				°C	Not fitted

Input Voltage Derating

Figure 1

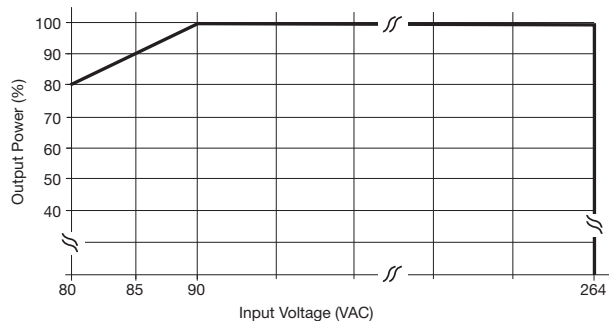

Start Up Delay From AC Turn On

Figure 2
Start up example from AC turn on
(230 VAC, 720 ms)

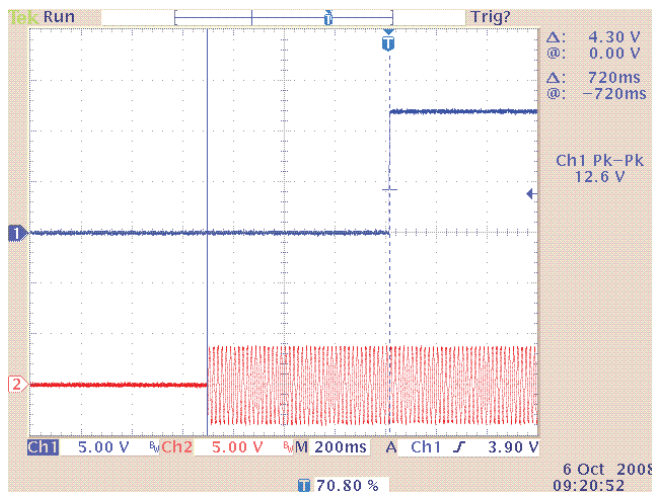

Hold Up Time From Loss of AC

Figure 3
Hold up example ECS45 at 45 W
load with 115 VAC input (17.2ms)

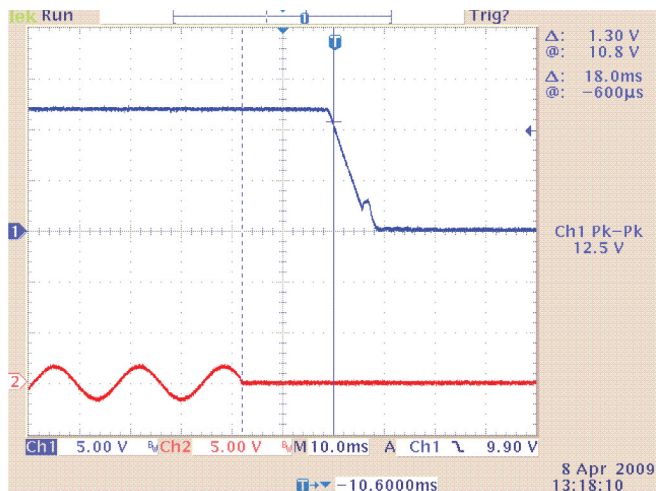

Typical Output Overshoot

Figure 4
Typical Output Overshoot
(ECS45US12, 230 VAC)

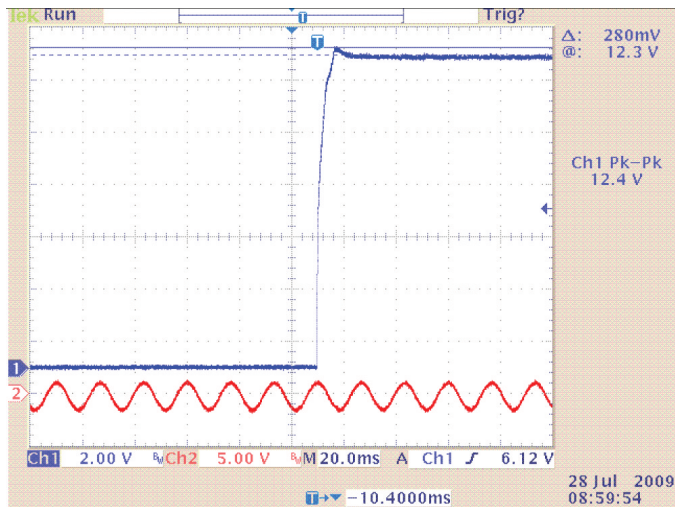

Output Ripple & Noise

Figure 5
ECS45US12 (45 W)
72 mV pk-pk ripple. 20 MHz BW

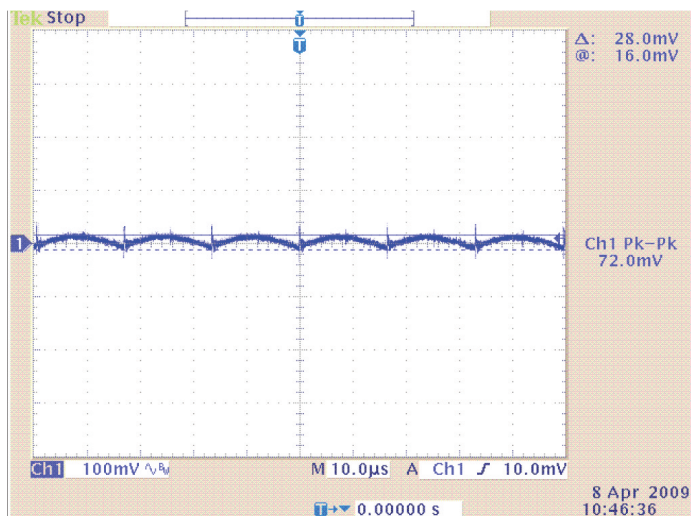

Output Ripple & Noise cont.

Figure 6
ECS45US48 (45 W)
188 mV pk-pk ripple. 20 MHz BW

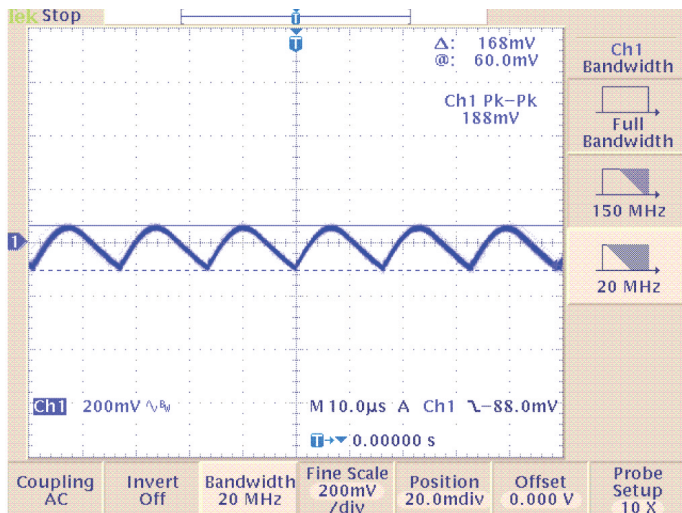

Output Overload Characteristic

Figure 7
Typical Overload
Characteristic
(ECS45US12 shown)

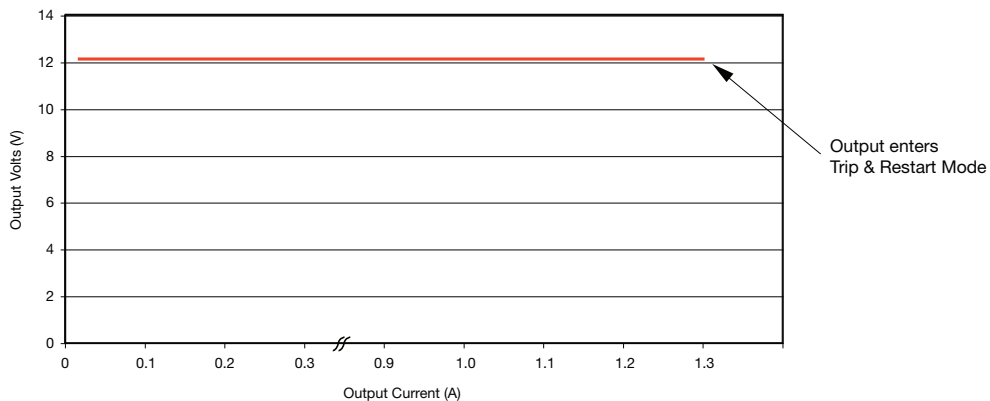

General Specifications

Characteristic	Minimum	Typical	Maximum	Units	Notes & Conditions
Efficiency		87		%	Full load (see fig.8 & 9)
Isolation: Input to Output Input to Ground Output to Ground	4000			VAC	
	1500			VAC	
	500			VDC	
Switching Frequency		65		kHz	
Power Density			7.9	W/in ³	
Mean Time Between Failure		1072		kHrs	MIL-HDBK-217F, Notice 2 +25 °C GB
		660			MIL-HDBK-217F, Notice 2 +50 °C GB
Weight			0.22 (100)	lb (g)	

Efficiency Versus Load

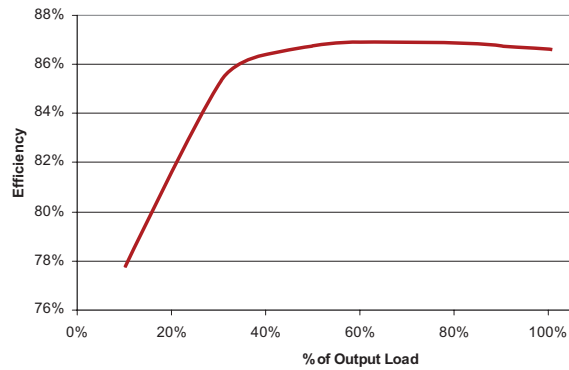

Figure 8
ECS45US12 at 230 VAC

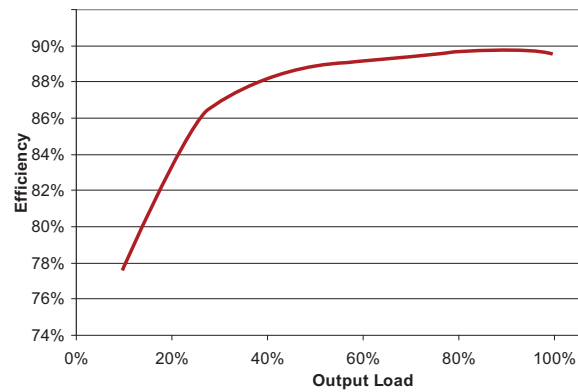

Figure 9
ECS45US48 at 230 VAC

Environmental

Characteristic	Minimum	Typical	Maximum	Units	Notes & Conditions
Operating Temperature	-20		+70	°C	Derate linearly from +50 °C at 2.5%/°C to 50% at 70 °C. (See fig.10 & Thermal Considerations)
Storage Temperature	-40		+85	°C	
Cooling					Convection cooled, see fig.10 & Thermal Considerations
Humidity	5		95	%RH	Non-condensing
Operating Altitude			3000	m	
Shock					3 x 30 g/11 ms shocks in both +ve & -ve directions along the 3 orthogonal axis, total 18 shocks.
Vibration					Three axis 5-500 Hz at 2 g x 10 sweeps

Derating Curve

Figure 10

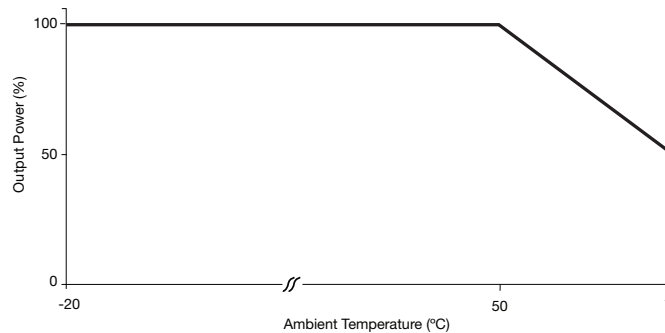

Electromagnetic Compatibility - Immunity

Phenomenon	Standard	Test Level	Criteria	Notes & Conditions
Low Voltage PSU EMC	EN61204-3	High severity level	as below	
Harmonic Current	EN61000-3-2	Class A		
Radiated	EN61000-4-3	3	A	
EFT	EN61000-4-4	3	A	
Surges	EN61000-4-5	Installation class 3	A	
Conducted	EN61000-4-6	3	A	
Dips and Interruptions	EN61000-4-11	Dip: 30% 10 ms	A	
		Dip: 60% 100 ms	B	
		Dip: 100% 5000 ms	B	
	EN60601-1-2	Dip: 30% 500 ms	A	
		Dip: 60% 100 ms	A	Load derating with 115 VAC input (typically 45% derate dependant on model & load)
		Dip: 100% 10 ms	A	
		Int.: >95% 5000 ms	B	

Electromagnetic Compatibility - Emissions

Phenomenon	Standard	Test Level	Criteria	Notes & Conditions
Conducted	EN55011/32	Class B		
Radiated	EN55011/32	Class B		ECS25
		Class A		ECS45/ECS60
Voltage Fluctuations	EN61000-3-3			

Safety Agency Approvals

Safety Agency	Safety Standard	Category
CB Report	IEC60950-1:2005 Ed 2 / IEC62368-1:2014	Information Technology
UL	UL 62368-1 & CAN/CSA C22.2 No. 62368-1-14	Information Technology
TUV	EN62368-1:2014/A11:2017	Information Technology
CE	LVD	

Safety Agency	Safety Standard	Category
CB Report	IEC60601-1 Ed 3 Including Risk Management	Medical
UL	ANSI/AAMI ES60601-1:2005 & CSA C22.2, No.60601-1:08	Medical
TUV	EN60601-1/A12:2006	Medical

Means of Protection		Category
Primary to Secondary	2 x MOPP (Means of Patient Protection)	IEC60601-1 Ed 3
Primary to Earth	1 x MOPP (Means of Patient Protection)	
Secondary to Earth	1 x MOPP (Means of Patient Protection)	

Equipment Protection Class	Safety Standard	Notes & Conditions
Class I & Class II	IEC60950-1:2005 Ed 2 / IEC62368-1:2014 & IEC60601-1 Ed 2	See safety agency conditions of acceptability for details

Mechanical Details - ECS25

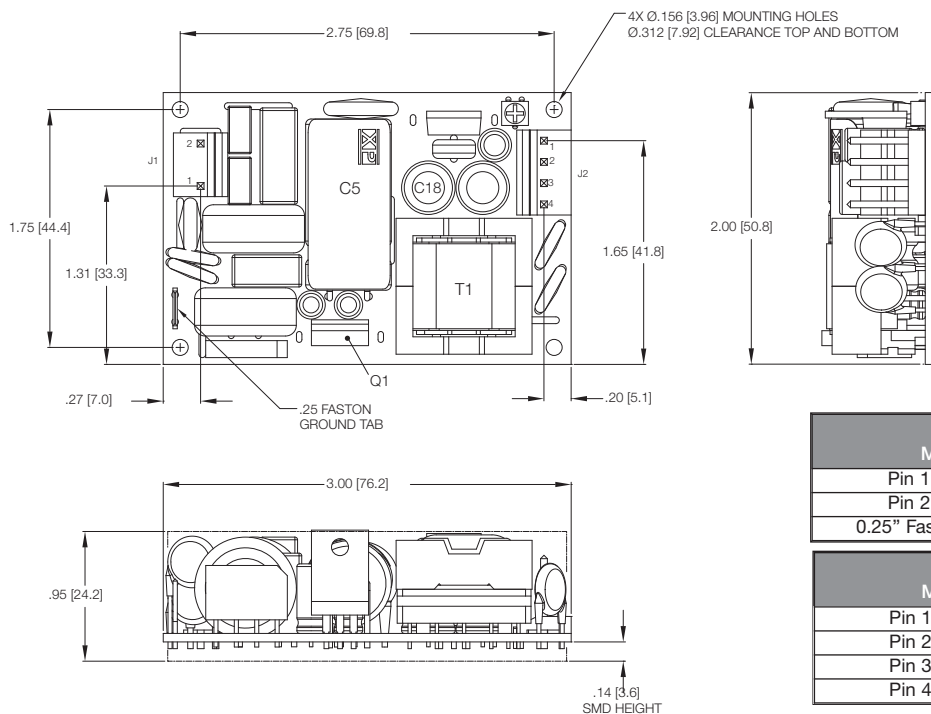

Input Connector J1 Molex PN 09-65-2038	
Pin 1	Line
Pin 2	Neutral
0.25" Faston	Earth

Input Connector J2 Molex PN 09-65-2048	
Pin 1	+V1
Pin 2	+V1
Pin 3	RTN
Pin 4	RTN

Notes

- All dimensions in inches (mm).
Tolerance .xx = ±0.02 (0.50); .xxx = ±0.01 (0.25)
- Weight 0.22 lbs (100 g)

J1 mates with Molex Housing PN 09-50-1031, J2 mates with Molex Housing PN 09-50-1041 and both with Molex Series 5194 Crimp Terminals
Faston ground tab requires insulated receptacle

Mechanical Details - ECS45US05

Weight: 2.20 lbs (1000 g)
Dimensions shown in inches (mm).

Input Connector J1 Molex PN 09-65-2038	
Pin 1	Line
Pin 2	Neutral
0.25" Faston	Earth

Input Connector J2 Molex PN 09-65-2048	
Pin 1	+V1
Pin 2	+V1
Pin 3	RTN
Pin 4	RTN

J1 mates with Molex Housing PN 09-50-1031, J2 mates with Molex Housing PN 09-50-1041 and both with Molex Series 5194 Crimp Terminals
Faston ground tab requires insulated receptacle

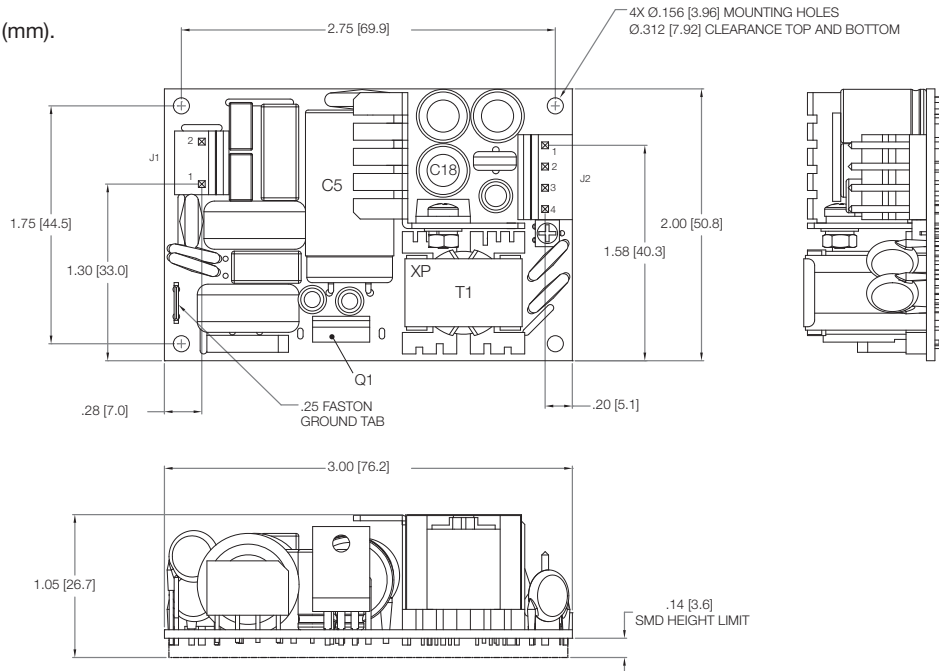

ECS45US other models

Input Connector J1 Molex PN 09-65-2038	
Pin 1	Line
Pin 2	Neutral
0.25" Faston	Earth

Input Connector J2 Molex PN 09-65-2048	
Pin 1	+V1
Pin 2	+V1
Pin 3	RTN
Pin 4	RTN

J1 mates with Molex Housing PN 09-50-1031, J2 mates with Molex Housing PN 09-50-1041 and both with Molex Series 5194 Crimp Terminals
Faston ground tab requires insulated receptacle

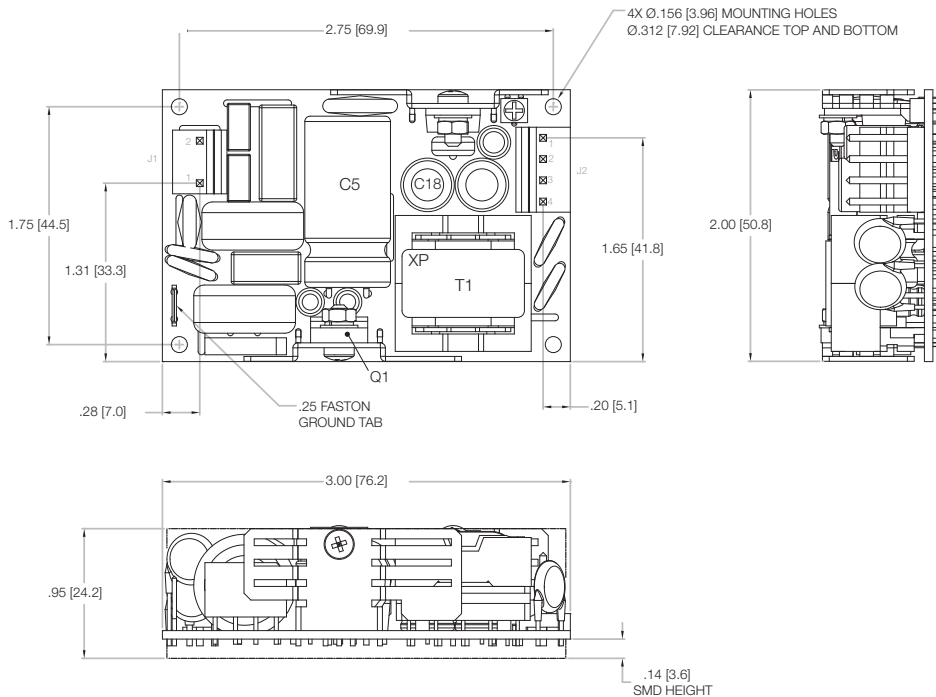

Notes

1. All dimensions in inches (mm).
Tolerance .xx = ±0.02 (0.50); .xxx = ±0.01 (0.25)

2. Weight: 0.22 lbs (100 g)

Mechanical Details - ECS60US05

Input Connector J1 Molex PN 09-65-2038	
Pin 1	Line
Pin 2	Neutral
0.25" Faston	Earth

J1 mates with Molex Housing PN 09-50-1031

Output Connector J2 Molex PN 09-65-2048	
Pin 1	+V1
Pin 2	+V1
Pin 3	RTN
Pin 4	RTN

J2 mates with Molex Housing PN 09-50-1041 and both with Molex Series 5194 Crimp Terminals
Faston ground tab requires insulated receptacle

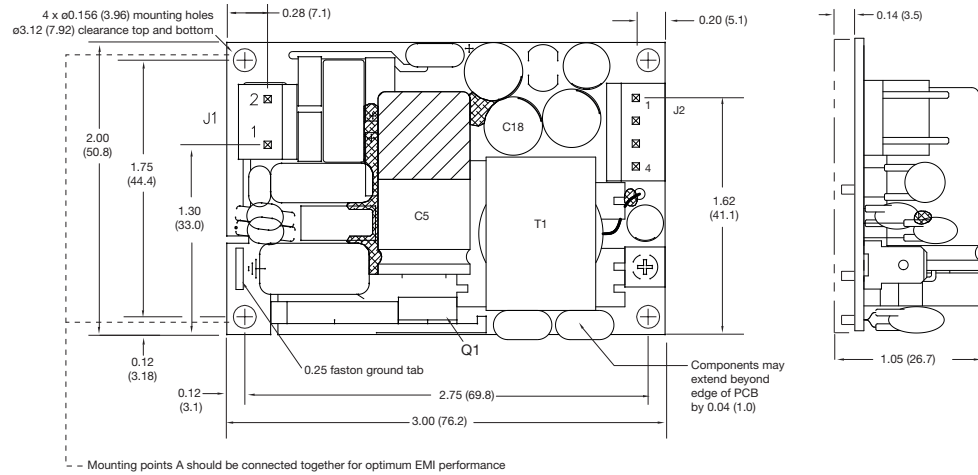

ECS60US other models

Input Connector J1 Molex PN 09-65-2038	
Pin 1	Line
Pin 2	Neutral
0.25" Faston	Earth

J1 mates with Molex Housing PN 09-50-1031

Output Connector J2 Molex PN 09-65-2048	
Pin 1	+V1
Pin 2	+V1
Pin 3	RTN
Pin 4	RTN

J2 mates with Molex Housing PN 09-50-1041 and both with Molex Series 5194 Crimp Terminals
Faston ground tab requires insulated receptacle

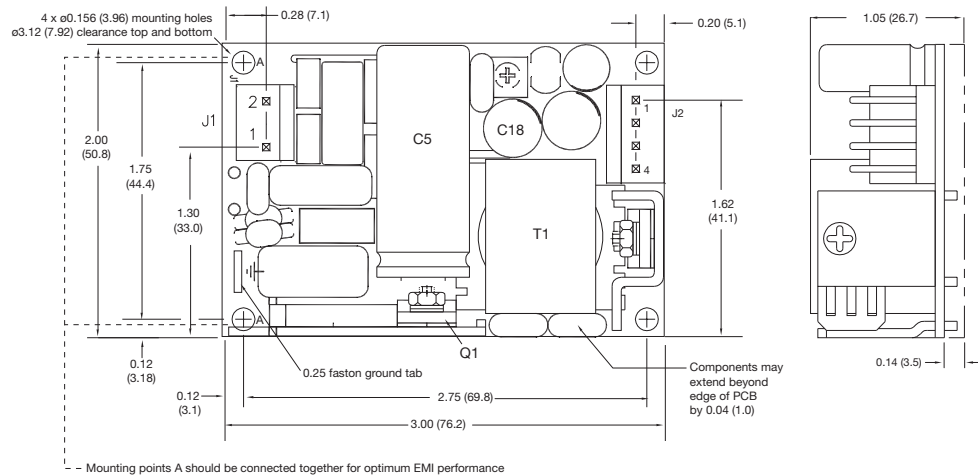

Notes

1. All dimensions in inches (mm).
Tolerance .xx = ±0.02 (0.50); .xxx = ±0.01 (0.25)

2. Weight: 0.22 lbs (100 g)

Covered Version - All models

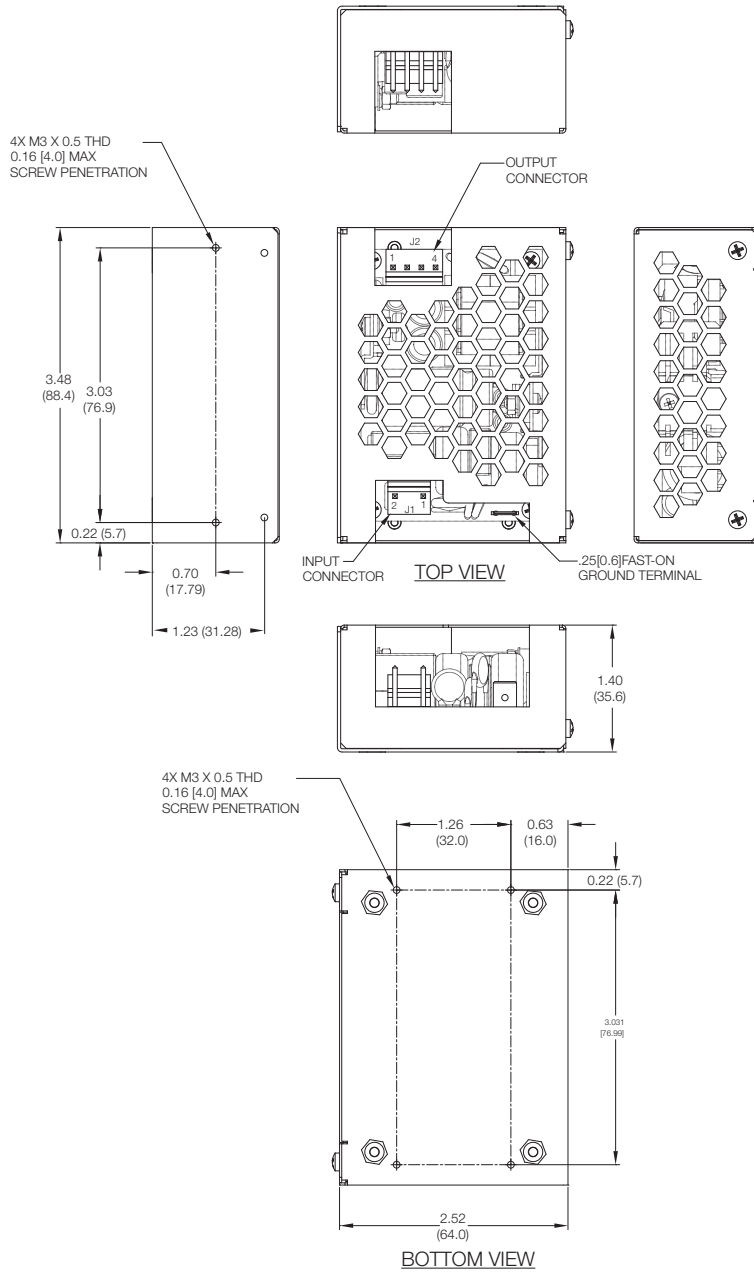

Thermal Considerations

In order to ensure safe operation of the PSU in the most adverse conditions permitted in the end-use equipment, the temperature of the components listed in the table below must not be exceeded. See mechanical drawings for component locations. Temperature should be monitored using K type thermocouples placed on the hottest part of the component (out of any direct air flow).

Temperature Measurements (Ambient ≤ 50 °C)	
Component	Max Temperature °C
T1	120 °C
Q1	110 °C
C5	105 °C
C18	105 °C