

# AC-DC Converter

**POWER  
SOLVE**

## PAE800 Series 800W Active PFC Single Output

[www.powersolve.com.tw](http://www.powersolve.com.tw)

### Features

- Universal AC Input with active PFC
- Programmable Output Voltage (0%-105%)
- Programmable Output Current (0%-105%)
- High Efficiency up to 93%
- +5V/0.5A or +8V/0.3A Auxiliary Output
- Intelligent LED Indicators
- 1U profile, High Power Density
- Forced current sharing for parallel operation
- Power OK signal (Power good, logic low)
- Remote ON/OFF, Remote Sense function
- OVP, OLP, OTP, SCP, Fan Failure Protections
- Constant Current Limiting
- Optional RS232 Function
- Built-in I<sup>2</sup>C Serial Data Bus



### Electrical Specification

Input Voltage	90-264VAC full range, 47-63Hz / 127-370VDC. Below 100VAC, derate load linearly to 90% at 90VAC.
Power Factor	0.95 at 230VAC / 0.98 at 115VAC at full load
AC Input Current (typ.)	9.3A at 100VAC / 4.7A at 230VAC
Inrush Current	30A at 115VAC / 60A at 230VAC
Leakage Current	<1mA at 240VAC
Output Voltage	See Table
Output Current	See Table
Voltage Tolerance	±2%
Voltage Adjust Range	±5.0% typical adjustment by potentiometer
Overload Protection	>105% of rated output power. Protection type: Constant current limiting
Overvoltage Protection	Variable OVP, 125% ±7% of Vout. Output latches off, recycle AC input to recover or inhibit
Over Temperature Protection	Shuts down output, recovers automatically (85°C ±5°C detect on heatsink on secondary side)
Auxiliary Power	+5V/0.5A or +8V/0.3A auxiliary output selected by user
Remote ON/OFF Control	External switch or NPN transistor to turn on/off
Power OK Signal	Open drain signal low when PSU turns on. Max. sink current 20mA, max drain voltage 40V
Output Voltage Programming	Adjustment of output voltage between 0-105% of rated output
Output Current Programming	Adjustment of output current between 0-105% of rated output
Operating Temperature Range	-20°C to +60°C. Above 50°C, derate linearly to 60% load at 60°C
Operating Humidity	20-90% RH non-condensing
Storage Temperature Range	-40°C to +85°C
Storage Humidity	10-95% RH non-condensing
Temperature Coefficient	±0.02%/°C (0-50°C)
Vibration	Compliance to IEC68-2-6, IEC68-2-64
Safety Standards	UL60950-1 2nd edition, TUV EN60950-1: 2006+A11 approved
Withstand Voltage	I/P-O/P: 3KVAC, I/P-FG: 1.5KVAC, O/P-FG: 0.5KVAC
Isolation Resistance	I/P-O/P, I/P-FG, O/P-FG: 100MΩ / 500VDC
EMI Conduction & Radiation	EN55022: 2006+A1: 2007 Class B, EN61204-3: 2000, EN61000-6-3: 2007
Harmonic Current	EN61000-3-2: 2006+A2: 2009 Class A, EN61000-3-3 : 2008
EMS Immunity	EN55024 : 1998+A1: 2001+A2 : 2003 light industry level criteria A, EN61204-3: 2000, EN61000-6-1: 2007
Cooling	Internal fan controlled by power rating & temperature, allow 50mm clearance at each end for airflow
Dimensions	249(L) x 127(W) x 41(H) mm
Weight	1.7Kg

#### Notes:

1. All parameters NOT specifically mentioned are measured at 230Vac input, rated load and 25°C ambient temperature
2. Ripple and noise are measured at 20MHz bandwidth by using a 12" twisted pair wire terminated with a 0.1μF ceramic & 47μF electrolytic capacitors across the output
3. Derating is required at low input voltages. Below 100Vac, derate linearly to 90% load at 90Vac
4. When parallel connected, only one unit may operate if the total output load is less than 5% of rated load
5. The power supply is considered a component which will be installed into a final equipment. The final equipment must be re-confirmed that it still meets EMC Directives

Email: [sales@powersolve.com.tw](mailto:sales@powersolve.com.tw)

# AC-DC Converter



[www.powersolve.com.tw](http://www.powersolve.com.tw)

## Output Voltage and Current Ratings

MODEL	OUTPUT VOLTAGE	MAX OUTPUT CURRENT	RIPPLE & NOISE	LINE REG.	LOAD REG.	POWER Max.	EFF.
PAE800-12	12V	66.7A	120mV p-p	±1%	±1%	800W	89%
PAE800-15	15V	53.4A	150mV p-p	±1%	±1%	801W	90%
PAE800-24	24V	33.5A	240mV p-p	±1%	±1%	804W	92%
PAE800-30	30V	26.7A	300mV p-p	±1%	±1%	801W	92%
PAE800-36	36V	22.3A	360mV p-p	±1%	±1%	802.8W	92%
PAE800-48	48V	16.7A	480mV p-p	±1%	±1%	801.6W	92%
PAE800-60	60V	13.4A	600mV p-p	±1%	±1%	804W	93%

## Mechanical & Connection Details

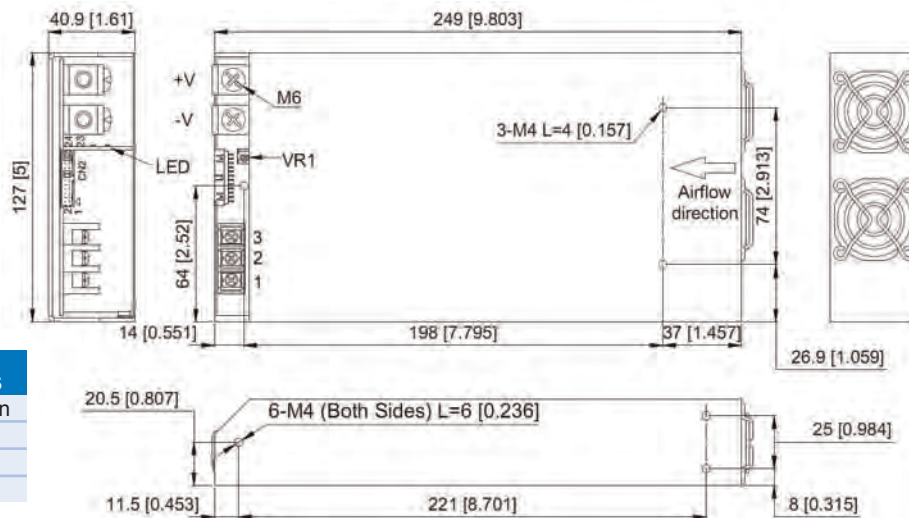

## Connections

Pin	Function
1	Live
2	Neutral
3	Earth

## Function Description of CN2, Control Connector

Pin No.	Function	Description	Mating Housing	Terminal
1	N.C.	For RS232 Receiver Function		
2	N.C.	For RS232 Transmission Function		
3, 7, 14	AUX	+5V/0.5A or +8V/0.3A Auxiliary power		
4, 8, 10, 12, 16, 20	GND	Ground		
5	SCL	Serial Data used in the I2C interface		
6	SDA	Serial Data used in the I2C interface		
9	VCI	V Program		
11	ACI	I Program	Molex	Molex
13	EN+	Inhibit ON/OFF +		
15	EN-	Inhibit ON/OFF -	51110-2451	50394-8200
17	PAR	Parallel operation current share		
18	VSET	Aux Output Set		
19	POK	Power OK		
21	VS-	Remote Sense -		
22	VO-	Negative Output Voltage		
23	VS+	Remote Sense +		
24	VO+	Positive Output Voltage		

## LED Status

LED Colour	LED Signal	Status
Green LED	Solid	Power OK (Local mode)
Orange LED	Solid	Power OK (Remote mode)
Green LED	Slow Blink	Power Standby
	Fast Blink	Over Voltage Protection (OVP)
	Solid	Over Load Protection (OLP)
Red LED	Slow Blink	Over Temperature Protection (OTP)
	Intermittent Blink	Fan Failure
	Interlace Blink	Power Failure

# AC-DC Converter



[www.powersolve.com.tw](http://www.powersolve.com.tw)

## De-rating Curve

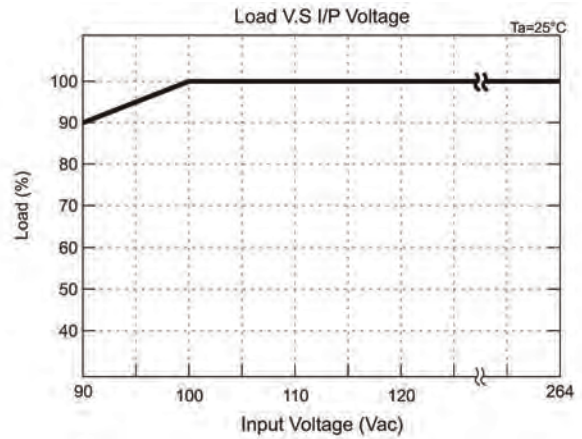
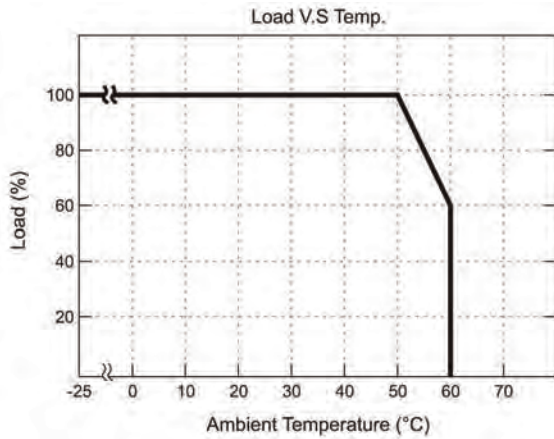

## Programming Input

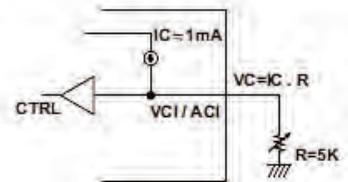
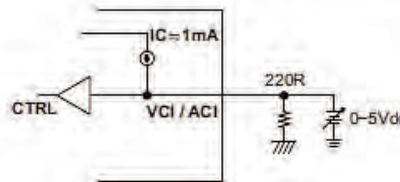
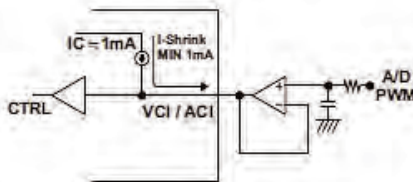
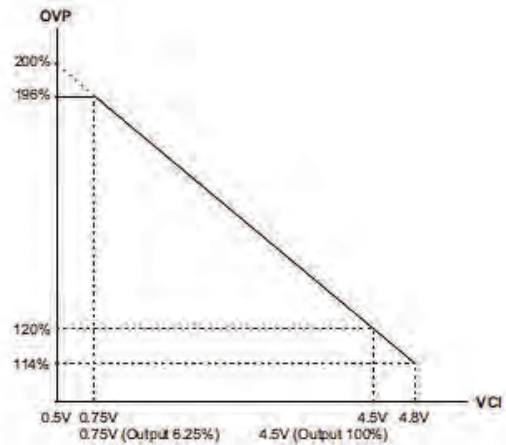
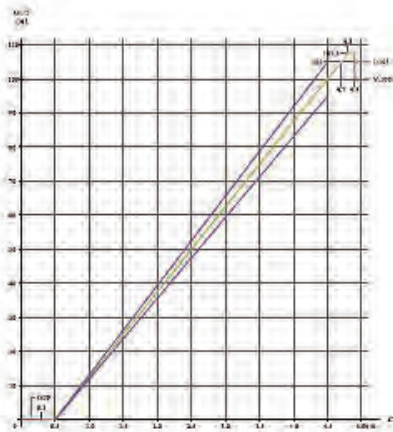



# AC-DC Converter



www.powersolve.com.tw

## Remote ON/OFF

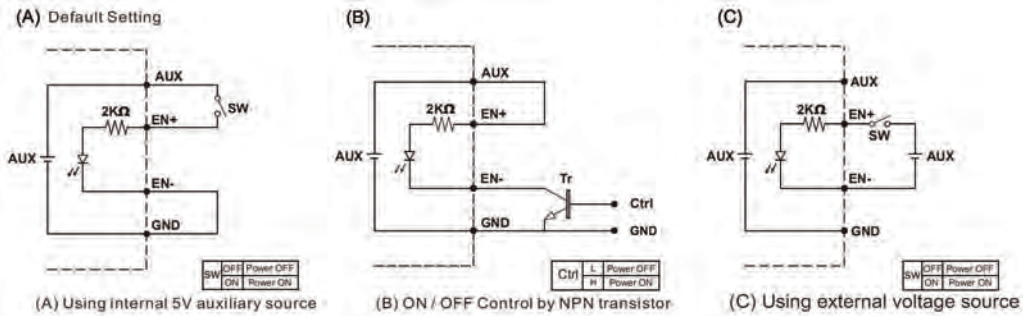

## Power OK Signal

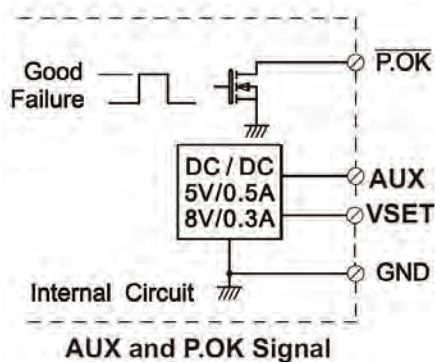

\*Place an additional capacitor to have a better performance of auxiliary power operation.

\*The grounding of "AUX" power should be connected to "GND" port. If "V-" is connected as Grounding, make sure to short the GND and V- ports.

VSET	Open	5V	(Default Setting)
	Short To GND	8V	

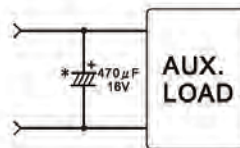

## Functions

1. Remote Sense

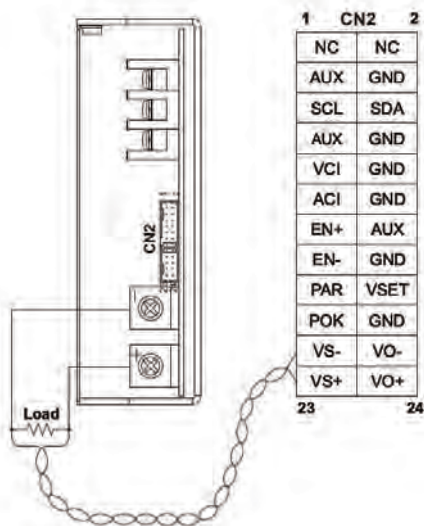

2. Local Sense (Default setting)

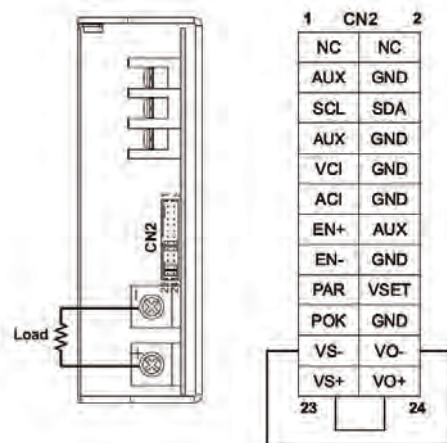

# AC-DC Converter



[www.powersolve.com.tw](http://www.powersolve.com.tw)

3. Current Sharing with Remote Sensing

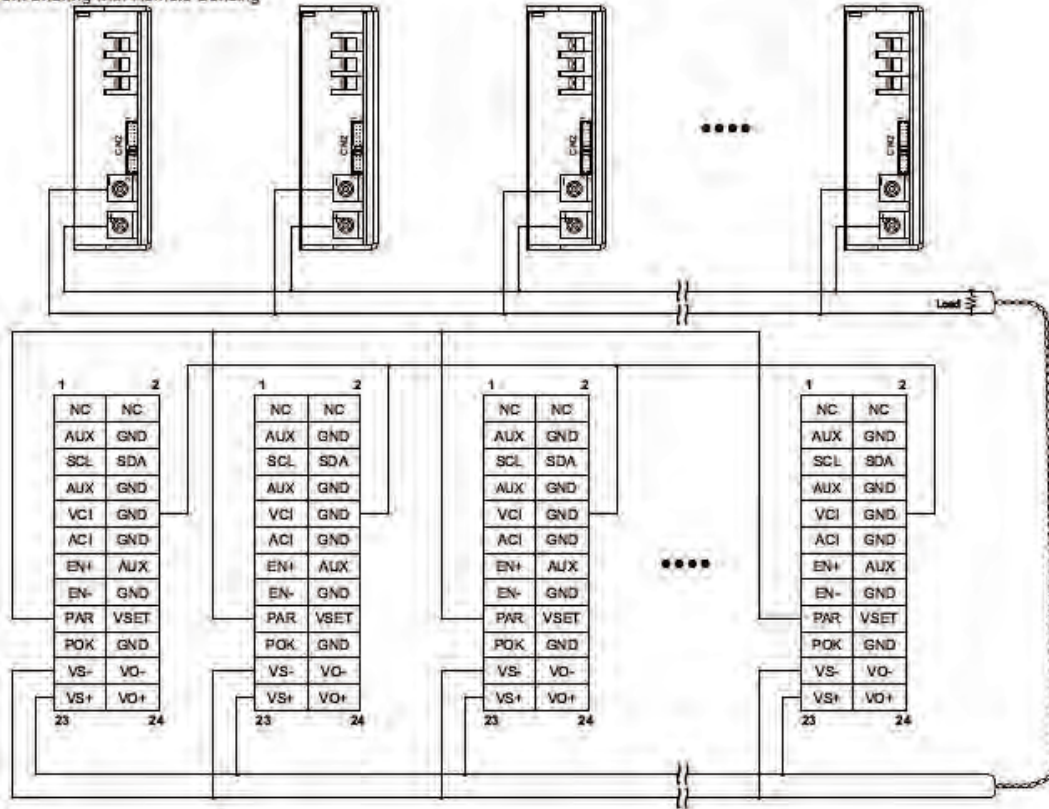

4. Current Sharing with Local Sensing

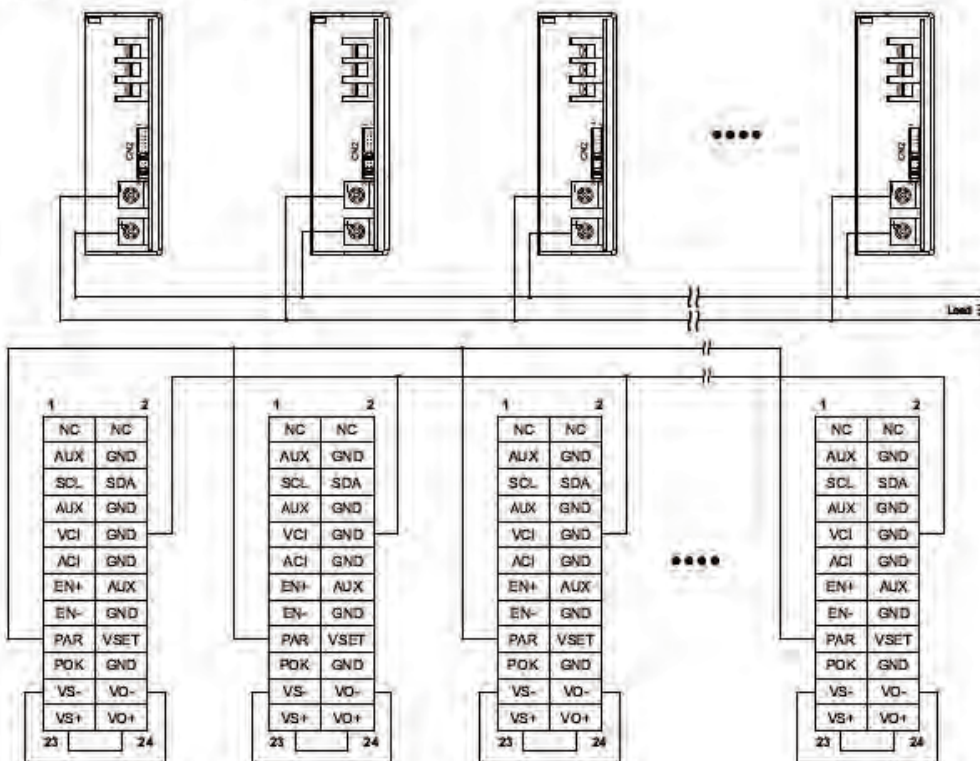

# AC-DC Converter

**POWER  
SOLVE**

[www.powersolve.com.tw](http://www.powersolve.com.tw)

## Installation Instructions

### 1. Mounting Directions

1-1 Recommended standard mounting methods:

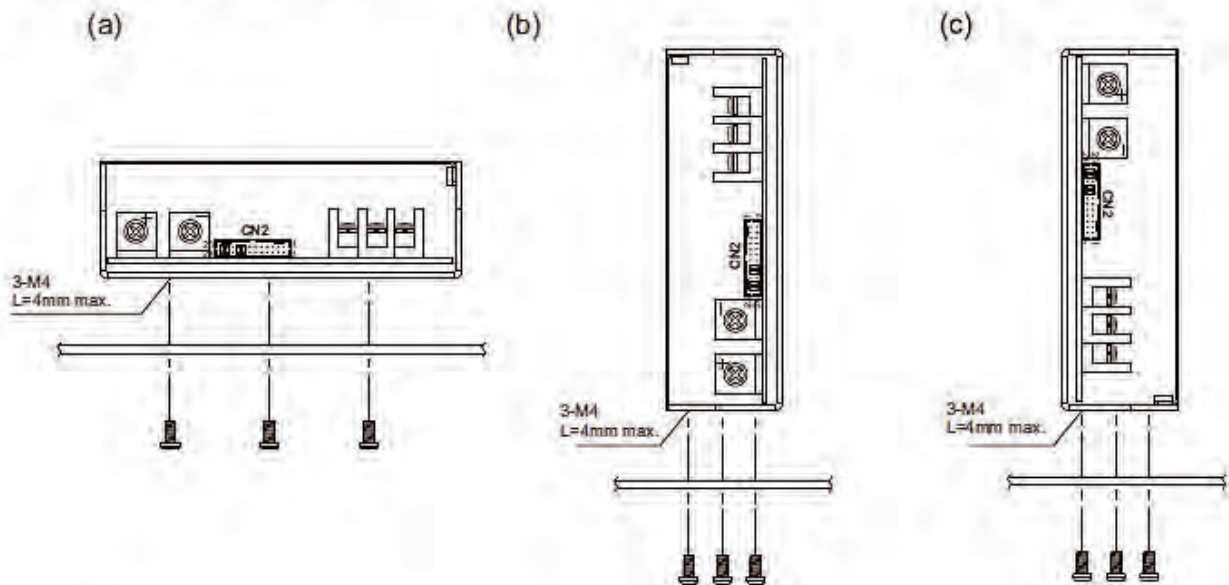

### 2. Mounting Method

2-1 There are ventilating holes on the front and back side panels, do not obstruct; allow 50mm at least for air flow.

2-2 The Maximum allowable penetration of screw is 4mm. Incomplete threading should not be penetrated.

2-3 Recommended the torque of mounting screw:  
M4 screw: 1.27N • m (13.0kgf • cm)

