

180 Watts

- 120W convection cooled -40°C to +70°C operation
- 180W with 10CFM forced air cooling -20°C to +70°C operation
- 4.3" x 2.5" footprint
- Low 1.16" profile U channel construction
- ITE & Medical (BF, 2 x MOPP) approvals
- Class B conducted & Class A radiated emissions
- Input voltage range 85 to 264VAC
- Output voltages from 12 to 48VDC
- No load input power <0.5W
- High efficiency, up to 94%
- 12V/0.5A fan output
- -40°C to +70°C operating temperature
- Full power to +50°C
- MTBF 300 khrs (MIL-HDBK-217F, +25°C GB)
- 3 year warranty



Dimensions:

UCP180:

4.24 x 2.47 x 1.16" (107.6 x 62.8 x 29.5 mm)

UCP180-C:

4.24 x 2.47 x 1.40" (107.6 x 62.8 x 35.5 mm)

The UCP180 series is designed to minimize the no load power consumption and maximize efficiency to facilitate equipment design to meet the latest environmental legislation. Approved for medical and ITE applications, this range of single output AC/DC power supplies are packaged in an ultra-low profile 1.16" height with a foot print of just 2.5" by 4.3". The UCP180 provides up to 180 W force-cooled or 120 W convection-cooled leading to very high power densities of 14.2 W/in³ or 9.4 W/in³ respectively. A 12 V, 500 mA fan supply is included in the design. The power supply contains two fuses and low leakage currents as required by medical applications and is safety approved to operate in a 70 °C ambient. The low profile and safety approvals covering ITE and medical standards along with conducted emissions to EN55011/32 level B enable the versatile UCP180 series to be suitable for a vast range of applications.

Models & Ratings

Output Voltage	Output Current		Fan Output ^(5,6)	Efficiency ⁽²⁾	Model Number ^(3,4)
	Convection-cooled	Forced-cooled ⁽¹⁾			
12.0 V	10.00 A	15.00 A	12 V/0.5 A	92%	UCP180PS12
15.0 V	8.00 A	12.00 A	12 V/0.5 A	92%	UCP180PS15
18.0 V	6.67 A	10.00 A	12 V/0.5 A	92%	UCP180PS18
24.0 V	5.00 A	7.50 A	12 V/0.5 A	92%	UCP180PS24
28.0 V	4.30 A	6.43 A	12 V/0.5 A	92%	UCP180PS28
36.0 V	3.33 A	5.00 A	12 V/0.5 A	92%	UCP180PS36
48.0 V	2.50 A	3.75 A	12 V/0.5 A	92%	UCP180PS48

Notes

1. Requires 10 CFM

2. Minimum average efficiencies measured at 25%, 50%, 75% & 100% of 180 W load and 230 VAC input

3. Add suffix -T for input and output screw terminals e.g. UCP180PS24-T

4. Add suffix -C for vented cover version e.g. UCP180PS24-C

5. Typical voltage, actual regulated voltage will be in range of 10.5 V to 11.3 V

6. Regulation of the fan output requires a minimum load of 10 W on the main output.

Input

Characteristic	Minimum	Typical	Maximum	Units	Notes & Conditions
Input Voltage - Operating	85	115/230	264	VAC	Derate output from 100% at 100 VAC to 90% at 90 VAC and 85% at 85 VAC. With optional convection cover fitted, derate from 120 W at 110 VAC to 100 W at 90 VAC
Input Frequency	47	50/60	63	Hz	
Power Factor		>0.9			230 VAC, 100% load. EN61000-3-2 class A
Input Current - Full Load		2.2/1.1		A	115/230 VAC
Inrush Current		120		A	230 VAC cold start, 25 °C
Earth Leakage Current		95/180	245	µA	115/230 VAC/50 Hz (Typ), 264 VAC/60 Hz (Max)
No load Input Power			0.5	W	
Input Protection	F3.15 A/250 V Internal fuse fitted in line and neutral.				

Output - Main Output

Characteristic	Minimum	Typical	Maximum	Units	Notes & Conditions
Output Voltage - V1	12		48	VDC	See Models and Ratings table
Initial Set Accuracy			±1	%	50% load, 115/230 VAC
Minimum Load	0			A	No minimum load required
Start Up Delay			2	s	115/230 VAC full load
Hold Up Time	10	19/13		ms	Min at full load, 115 VAC. Typical at 120 W/ 180 W
Drift			±0.02	%	After 20 min warm up
Line Regulation			±0.5	%	90-264 VAC
Load Regulation			±0.5	%	0-100% load
Transient Response			4	%	Recovery within 1% in less than 500 µs for a 50-75% and 75-50% load step
Over/Undershoot		5	10	%	Full load
Ripple & Noise			1	% pk-pk	20 MHz bandwidth and 10 µF electrolytic capacitor in parallel with 0.1 µF ceramic capacitor
Overvoltage Protection	110		140	%	Vnom, recycle input to reset
Overload Protection	110		175	%	Of forced cooled rating
Short Circuit Protection					Trip & Restart
Temperature Coefficient			0.02	%/°C	

General

Characteristic	Minimum	Typical	Maximum	Units	Notes & Conditions
Efficiency		94		%	230 VAC Full load (see fig. 1 to 2)
Isolation: Input to Output Input to Ground Output to Ground	4000			VAC	2 MOPP
	1500			VAC	1 MOPP
	1500			VAC	1 MOPP
Patient Leakage Current		50	80	μA	At 264 VAC, 60 Hz
Switching Frequency	37		130	kHz	PFC
	50		80	kHz	Main converter
Power Density			12.2/8.1	W/in ³	Forced/convection-cooled
Mean Time Between Failure		300		kHrs	MIL-HDBK-217F, Notice 2 +25 °C GB
Weight		0.53 (240)		lb(g)	For U channel version

Efficiency Vs Load

Figure 1
UCP180PS12 at 180 W

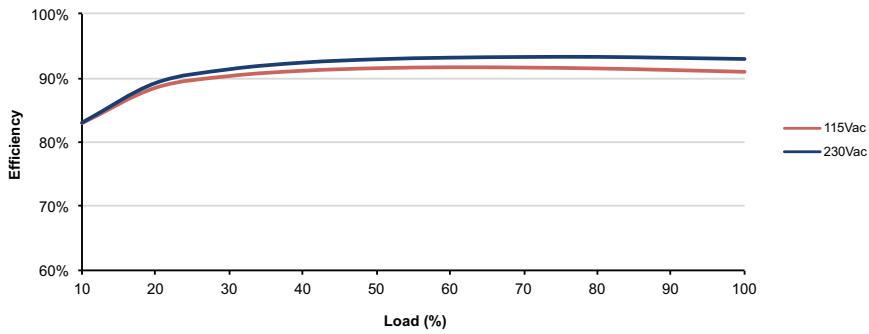
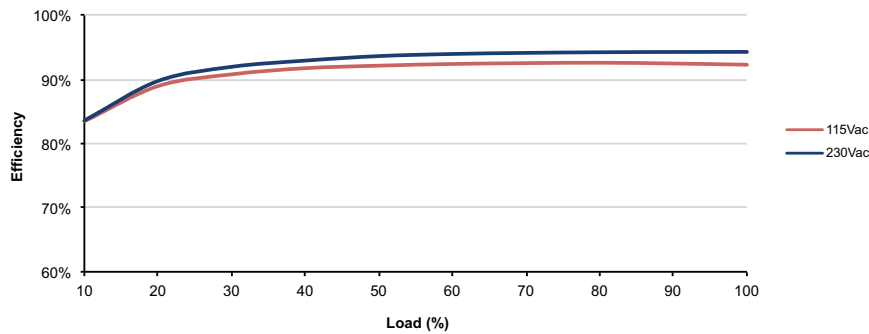

Figure 2
UCP180PS24 at 180 W



Environmental

Characteristic	Minimum	Typical	Maximum	Units	Notes & Conditions
Operating Temperature	-40		+70	°C	-40 °C for 120 W load, -20 °C for 180 W load, See derating curve, fig.3 and fig.4
Storage Temperature	-40		+85	°C	
Cooling	10			CFM	Forced-cooled > 120W
Humidity	5		95	%RH	Non-condensing
Operating Altitude			5000/4000	m	ITE/Medical
Shock	±3 x 30g shocks in each plane, total 18 shocks. 30g = 11ms (+/- 0.5msecs), half sine. Conforms to EN60068-2-27				
Vibration	Single axis 10-500 Hz at 2g sweep and endurance at resonance in all 3 planes. Conforms to EN60068-2-6				

Temperature Derating Curves

Figure 3 - 120 W Convection Cooled

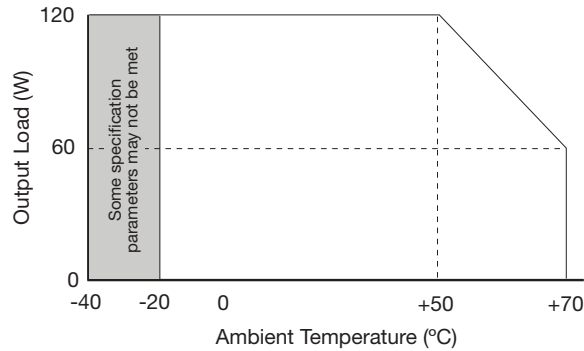
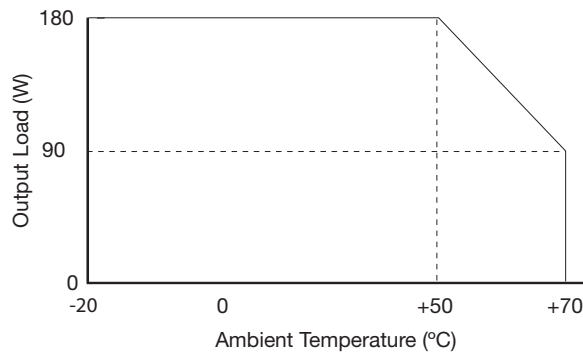

Figure 4 - 180 W Forced Cooled



EMC: Emissions

Phenomenon	Standard	Test Level	Criteria	Notes & Conditions
Conducted	EN55011/32	Class B		
Radiated	EN55011/32	Class A		Class B with King Core ferrites Output cable: KCF-130-B Input cable for 120 W load: K5B RC 14x28.5x7-M for all models with additional KCF-130-B on 48V version. Input cable for 180 W load: K5B RC 14x28.5x7-M plus KCF-130-B.
Harmonic Current	EN61000-3-2	Class A		
Voltage Functions	EN61000-3-3			

EMC: Immunity

Phenomenon	Standard	Test Level	Criteria	Notes & Conditions
Medical Device EMC	IEC60601-1-2	Ed.4.0 : 2014	as below	
Low Voltage PSU EMC	EN61204-3	High severity level	as below	
ESD	EN61000-4-2	4	A	±8kV contact, ±15kV air
Radiated	EN61000-4-3	3	A	
EFT	EN61000-4-4	3	A	
Surges	EN61000-4-5	Installation class 3	A	
Conducted	EN61000-4-6	3	A	
Magnetic Fields	EN61000-4-8	4	A	
Dips and Interruptions	EN55024 (100 VAC)	Dip >95% (0 VAC), 8.3 ms	A	
		Dip 30% (70 VAC), 416 ms	A	
		Dip >95% (0 VAC), 4160 ms	B	
	EN55024 (240 VAC)	Dip >95% (0 VAC), 10.0 ms	A	
		Dip 30% (168 VAC), 500 ms	A	
		Dip >95% (0 VAC), 5000 ms	B	
	EN60601-1-2 (100 VAC)	Dip 100% (0 VAC), 10.0 ms	A	
		Dip 100% (0 VAC), 20 ms	B	
		Dip 60% (40 VAC), 100 ms	B	Criteria A with load derated to 35 W
		Dip 30% (70 VAC), 500 ms	A	
		Dip 100% (0 VAC), 5000 ms	B	
	EN60601-1-2 (240 VAC)	Dip 100% (0 VAC), 10.0 ms	A	
		Dip 100% (0 VAC), 20 ms	B	
		Dip 60% (96 VAC), 100 ms	B	Criteria A with load derated to 160 W
		Dip 30% (168 VAC), 500 ms	A	
Dip 100% (0 VAC), 5000 ms		B		

Safety Approvals

Safety Agency	Safety Standard	Notes & Conditions
CB Report	IEC60950-1-1, IEC62368-1	Information Technology
UL	UL62368-1	Information Technology
TUV	EN62368-1	Information Technology
CB Report	IEC60601-1	Medical
UL	ES60601-1	Medical
TUV	EN60601-1	Medical

Isolation	Safety Standard	Notes & Conditions
Primary to Secondary	2 x MOPP (Means of Patient Protection)	
Primary to Earth	1 x MOPP (Means of Patient Protection)	
Secondary to Earth	1 x MOPP (Means of Patient Protection)	Suitable for use in BF applied part applications

Mechanical Details

Standard U-Channel Version

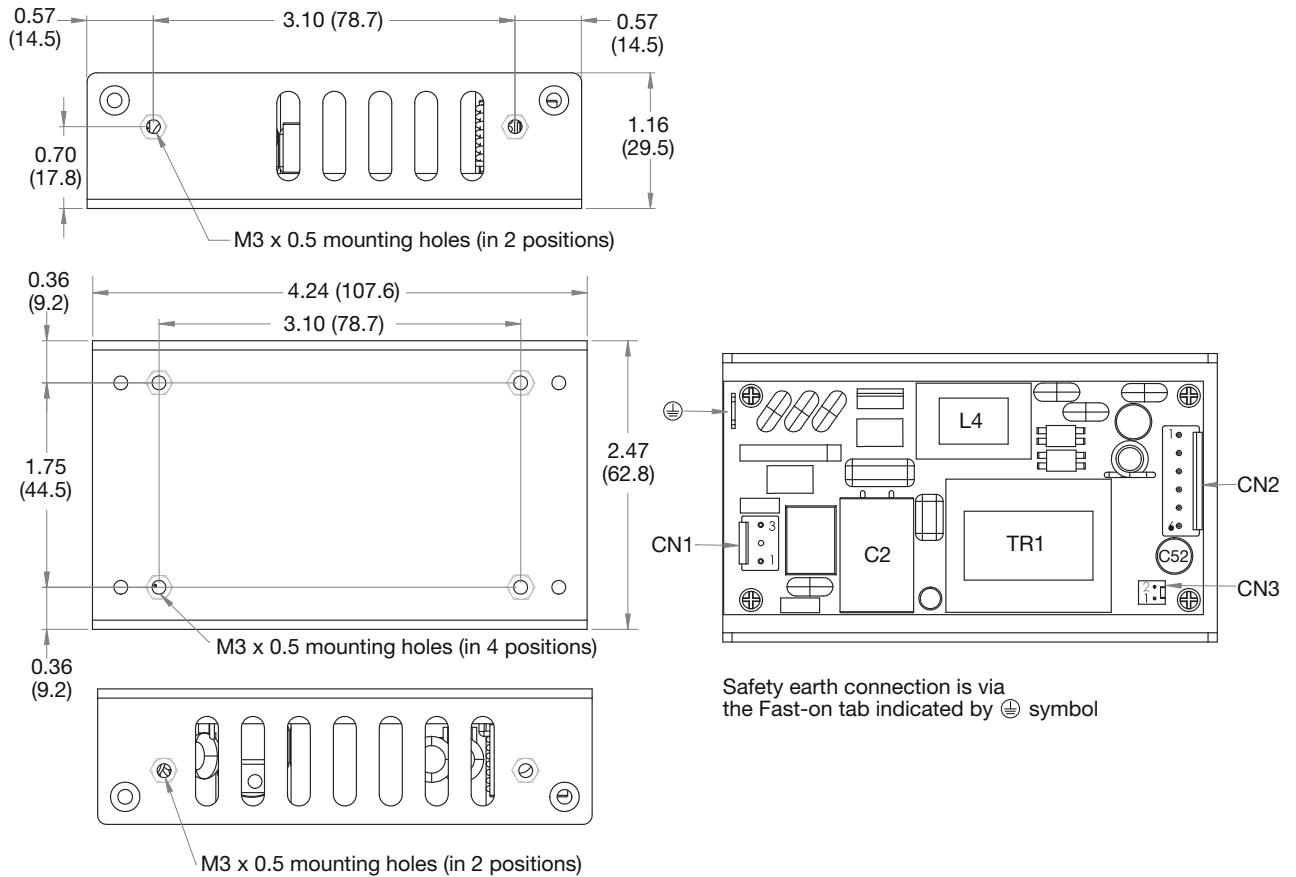

Safety earth connection is via the Fast-on tab indicated by \oplus symbol

CN1	
Pin 1	AC-L
Pin 2	
Pin 3	AC-N

Mates with JST VHR-3N housing and SVH-21T-P1.1 crimps

CN2	
Pin 1	+Vo
Pin 2	+Vo
Pin 3	+Vo
Pin 4	Com
Pin 5	Com
Pin 6	Com

Mates with JST VHR-6N housing and SVH-21T-P1.1 crimps

CN3	
Pin 1	Fan -
Pin 2	Fan +

Mates with Molex 22-01-1022 housing and 2759 crimps

Notes

- All dimensions shown in inches (mm).
Tolerance: ± 0.02 (0.5)
- Weight: 0.53 lbs (240 g) approx.

Mechanical Details

Covered Version (-C suffix)

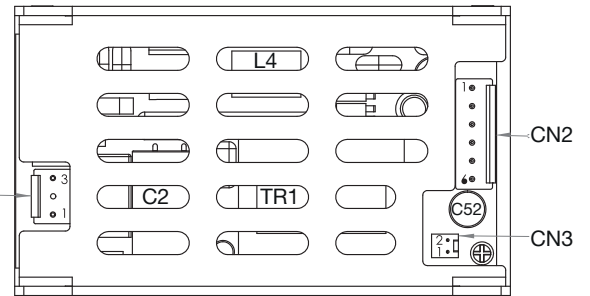
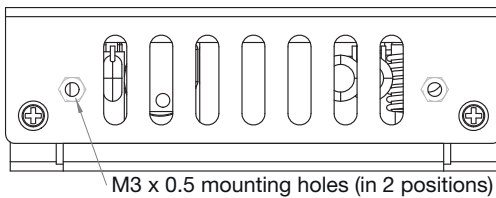
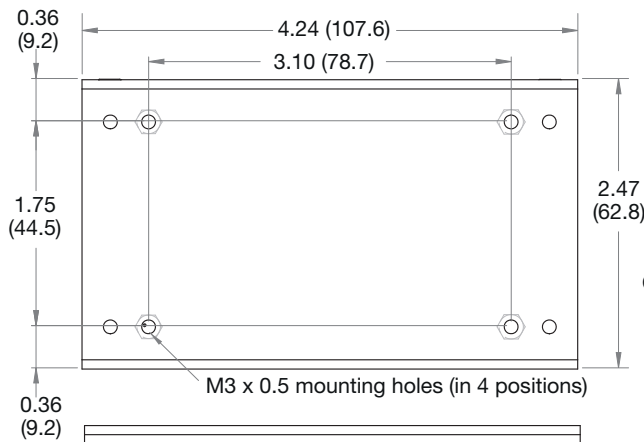
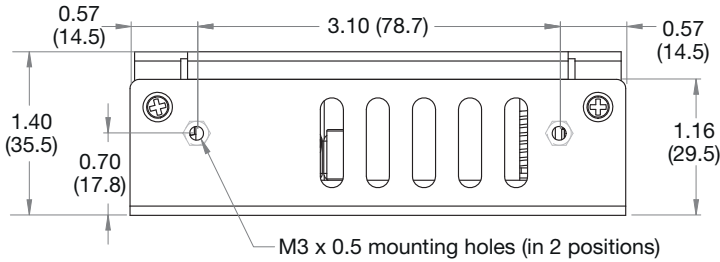

Safety earth connection is via any of the U-channel mounting points

CN1	
Pin 1	AC-L
Pin 2	
Pin 3	AC-N

Mates with JST VHR-3N housing and SVH-21T-P1.1 crimps

CN2	
Pin 1	+Vo
Pin 2	+Vo
Pin 3	+Vo
Pin 4	Com
Pin 5	Com
Pin 6	Com

Mates with JST VHR-6N housing and SVH-21T-P1.1 crimps

CN3	
Pin 1	Fan -
Pin 2	Fan +

Mates with Molex 22-01-1022 housing and 2759 crimps

Notes

- All dimensions shown in inches (mm).
Tolerance: ± 0.02 (0.5)
- Weight: 0.61 lbs (275 g) approx.

Thermal Considerations

In order to ensure safe operation of the PSU in the end-use equipment, the temperature of the components listed in the table below must not be exceeded. Temperature should be monitored using K type thermocouples placed on the hottest part of the component (out of direct air flow). See Mechanical Details for component locations.

Temperature Measurements (At Maximum Ambient)	
Component	Max Temperature °C
TR1 Coil	110°C
L4 Coil	120°C
C2	105°C
C52	105°C

Service Life

The estimated service life of the UCP180 is determined by the cooling arrangements and load conditions experienced in the end application. Due to the uncertain nature of the end application this estimated service life is based on the actual measured temperature of a key capacitor within the product when installed in the end application,

The graph below expresses the estimated lifetime of a given component temperature and assumes continuous operation at this temperature.

Estimated Service Life vs Component Temperature

Figure 5

